

Classification:

HA16-006

Reference:

ITB16-037

Date:

September 27, 2016

2014-2016 Q50; INCORRECT DIFFERENCE IN HVAC VENT TEMPERATURES

APPLIED VEHICLES: 2014-2016 Q50 and Q50 Hybrid (V37)

APPLIED VIN and DATE: 2014 Q50: ALL

2014-2015 Q50 Hybrid: ALL

 2015 Q50 vehicles built before: JN1BV7AR(*)FM 424062 and December 12, 2015
 JN1BV7AP(*)FM 359111 and December 12, 2015

 2016 Q50 vehicles built before: JN1CV7AR(*)GM 250330 and December 16, 2015
 JN1CV7AP(*)GM 200286 and December 17, 2015

 2016 Q50 Hybrid vehicles built before: JN1AV7AR(*)GM 530016 and December 16, 2015
 JN1AV7AP(*)GM 490021 and December 16, 2015

IF YOU CONFIRM:

The driver side vent is warmer by 10°F or more than the passenger side with the HVAC's dual temp mode selected and the A/C set on both sides at 60°F.

- This incident, if it should occur, may be intermittent.

ACTION:

Using the **SERVICE PROCEDURE** in this bulletin, replace the Air Mix Door Motor LH and the Air Mix Door Lever LH with the ones from the **PARTS INFORMATION** section of this bulletin.

NOTE: It is **not necessary to remove** either the Instrument Panel or the Heater Case to perform the following procedure. **Do not** remove either the Instrument Panel or the Heater Case from the vehicle for this procedure.

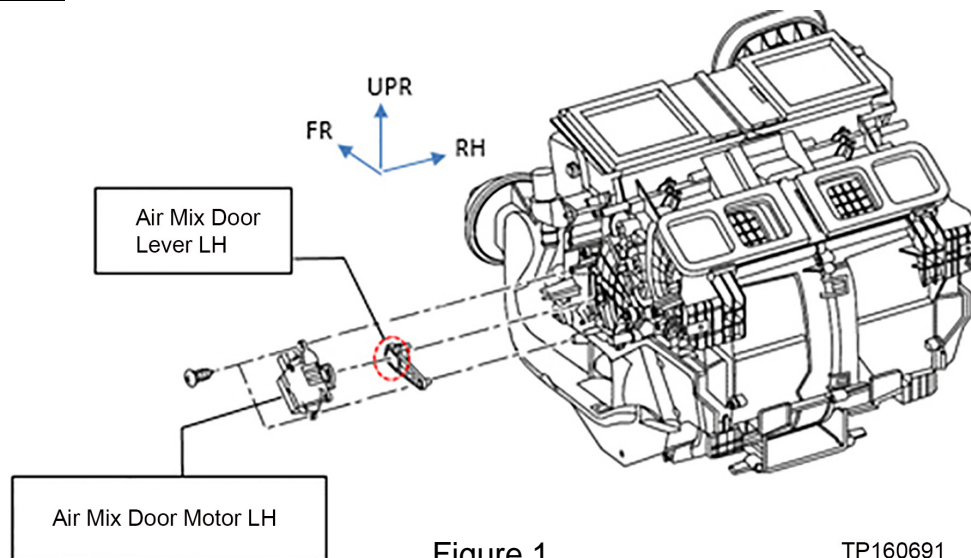

Figure 1

TP160691

IMPORTANT: The purpose of **ACTION** (above) is to give you a quick idea of the work you will be performing. You **MUST** closely follow the entire **SERVICE PROCEDURE** (starting on page 2) as it contains information that is essential to successfully completing this repair.

Infiniti Bulletins are intended for use by qualified technicians, not 'do-it-yourselfers'. Qualified technicians are properly trained individuals who have the equipment, tools, safety instruction, and know-how to do a job properly and safely. **NOTE:** If you believe that a described condition may apply to a particular vehicle, **DO NOT** assume that it does. See your Infiniti retailer to determine if this applies to your vehicle.

SERVICE PROCEDURE

Air Mix Door Motor LH and Air Mix Door Lever LH Removal

1. Remove the instrument panel side finisher LH with a suitable finesse tool (see Figure 2).
2. Remove the instrument lower panel LH (see Figure 3).
 - a. Disconnect the aspirator duct.
 - b. Disconnect all electrical connections, and then disconnect all harness clips.
 - c. Disconnect the hood release handle and cable.



Figure 2

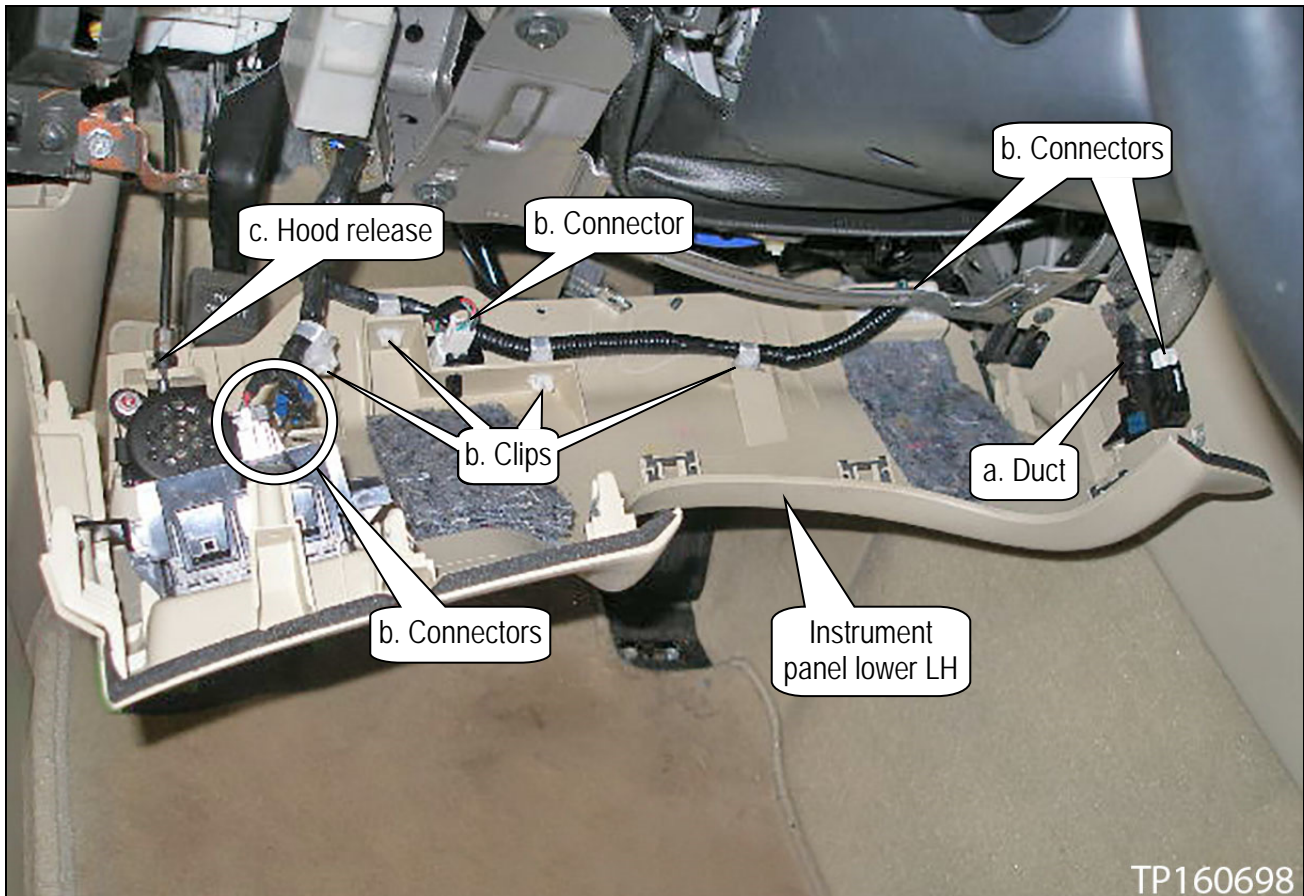

Figure 3

3. Remove the four (4) bolts, and then remove bracket 1 (see Figure 4).

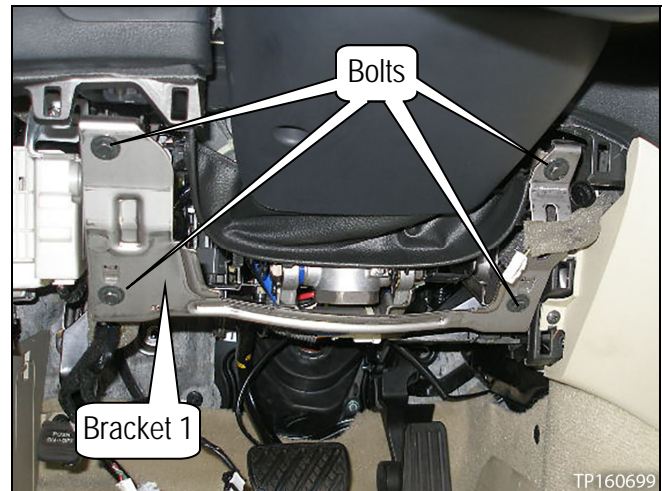

Figure 4

4. Remove the heater duct.
 - a. Unfasten the heater duct by inserting a flat blade screwdriver and GENTLY twisting it to release the duct from the clip (see Figure 5).
 - b. After unfastening at the top, the heater duct will lift off a pin at the duct bottom.

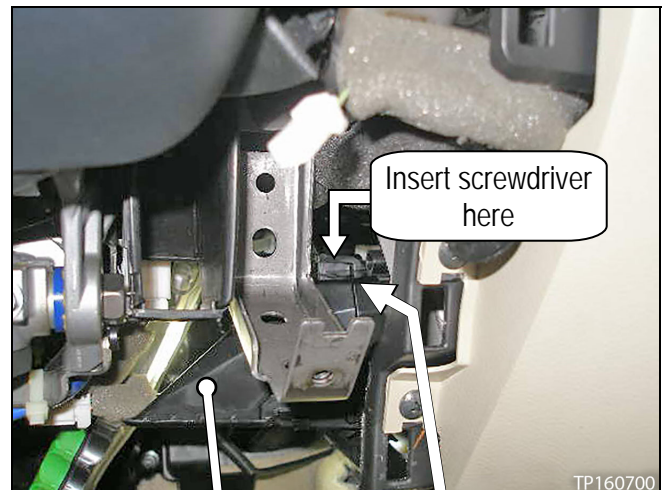

Figure 5



Figure 6

5. Remove bracket 2 (see Figure 7).
 - a. Remove the screw.
 - b. Turn the bracket to get to the backside of the harness clip, and then pinch with a suitable tool to unfasten it.

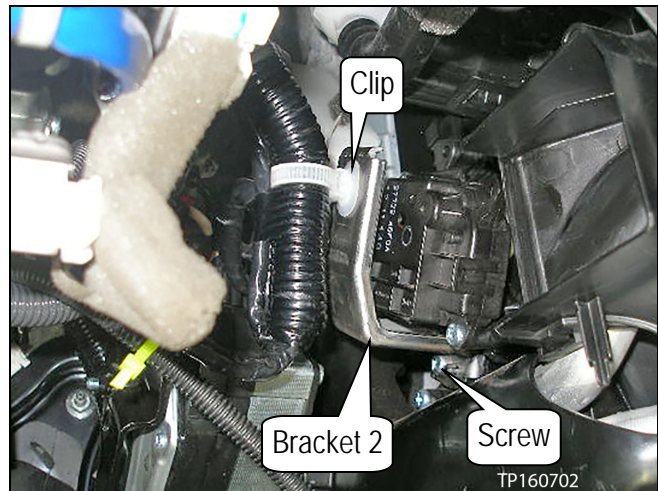

Figure 7

6. Remove the air mix door motor LH (see Figure 8).
 - a. Remove the two (2) screws.
 - b. Pull off the air mix door motor LH, and then disconnect its electrical connector.

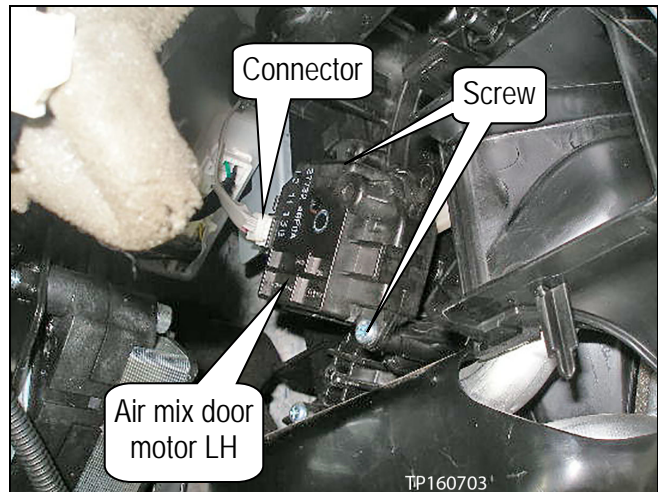

Figure 8

7. Remove the air mix door lever LH.
 - Pull the lever straight out.
 - See next page, Figure 10 for more detail.



Figure 9

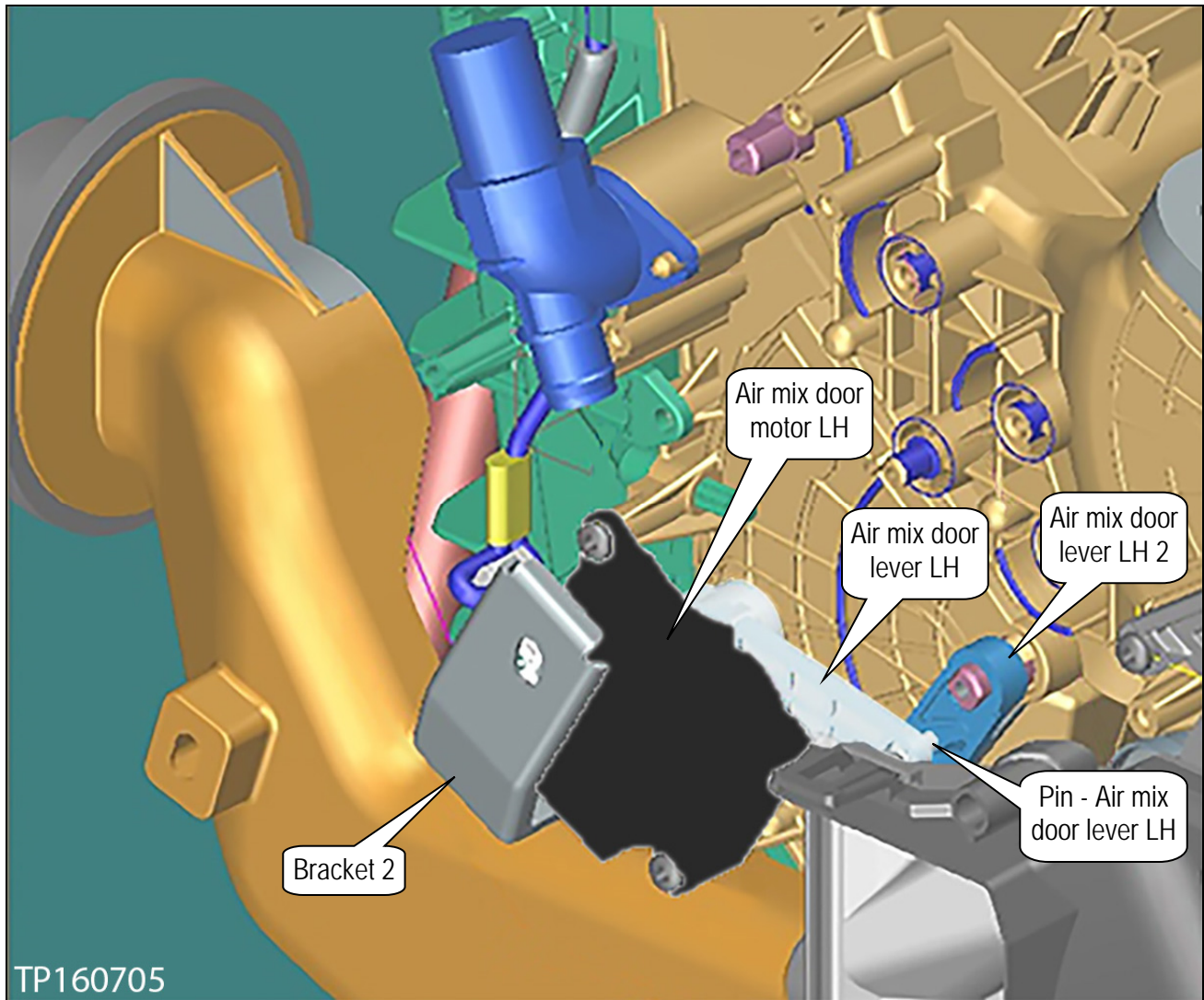

Figure 10

Replacement Air Mix Door Motor and Lever Installation

1. Install the new air mix door motor LH and air mix door lever LH in reverse order of removal.

NOTE:

- For replacement parts, see **PARTS INFORMATION**.
- Add grease as needed to the air mix door lever LH's pin, and the channel where the pin fits into air mix door lever LH 2.
 - Use multipurpose extreme pressure lithium grease or equivalent.
- When installing the air mix door lever LH, make sure its pin is inserted in the cam section of air mix door lever LH 2 (see Figure 10 and 11).

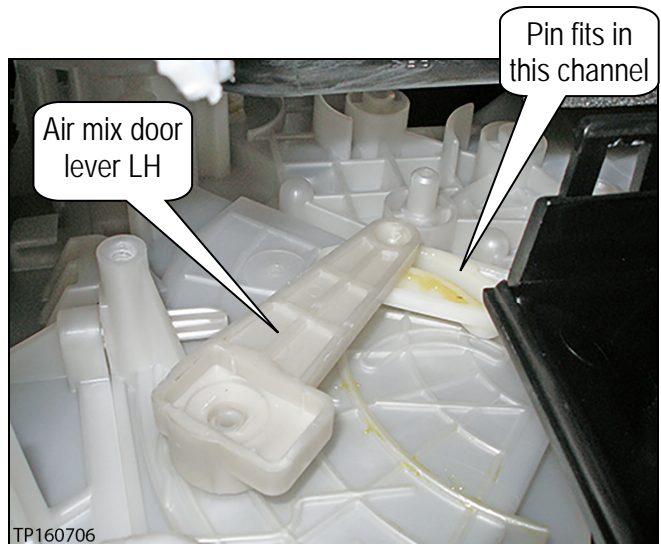

Figure 11

PARTS INFORMATION

DESCRIPTION	PART NUMBER	QTY
ACTUATOR ASSY-AIR MIX	27742-4GF0A	1
LEVER-AIR MIX DOOR	27156-4GF1A	1

CLAIMS INFORMATION

Submit a Primary Part (PP) type line claim using the following claims coding:

DESCRIPTION	PFP	OP CODE	SYM	DIA	FRT
Replace Air Mix Door Motor and Lever	27742-4GF0A	TX46AA	ZE	32	0.5

